

# EFI-P2 A 80/0.5



## Specificatii

Cod ETI	002061144
Descriere	EFI-P2 A 80/0.5
Denumire clasă	Diferențial RCCB
Curent nominal (A)	80
Tip	A
Tensiunea nominală(V)	240
Număr de poli	1+N
Frecvență nominală (Hz)	50/60
Standarde	IEC/EN 61008
Terminale (mm <sup>2</sup> )	1-25
Curentul rezidual de operare	0.5
Timp de declansare	Instantaneu
Curent nominal de scurtcircuit Inc (kA)	10

[Pagina de produse online](#)

## Alta documentatie



[Manual de instructiuni](#)

[Catalog caracteristici tehnice](#)

[Certificate](#)

[Model 3D](#)

[COM\\_ETISTORE\\_ITEM\\_DOCTYPE\\_Instruction manual](#)

[Declaratie CE](#)

# Desen cotat

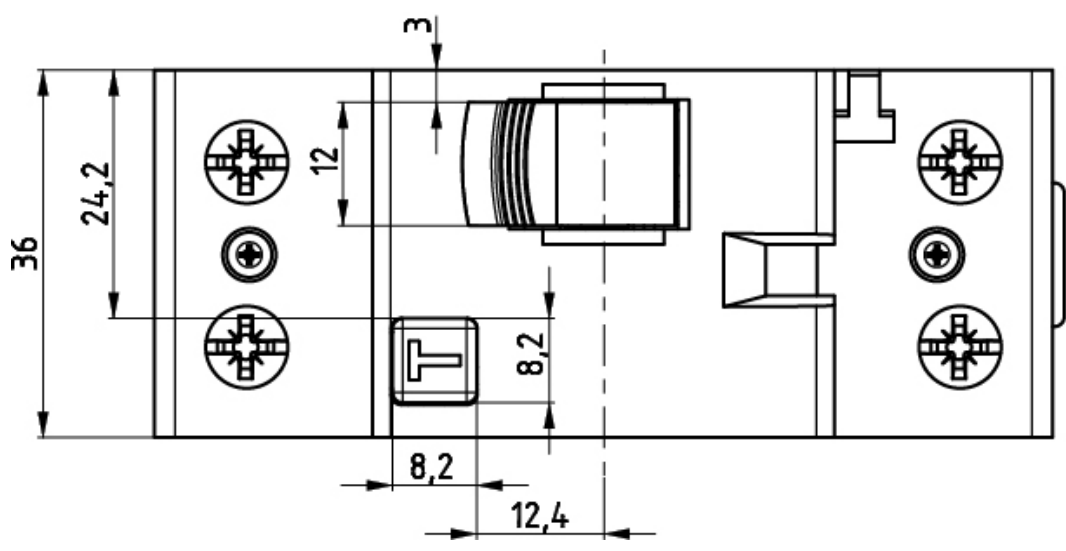
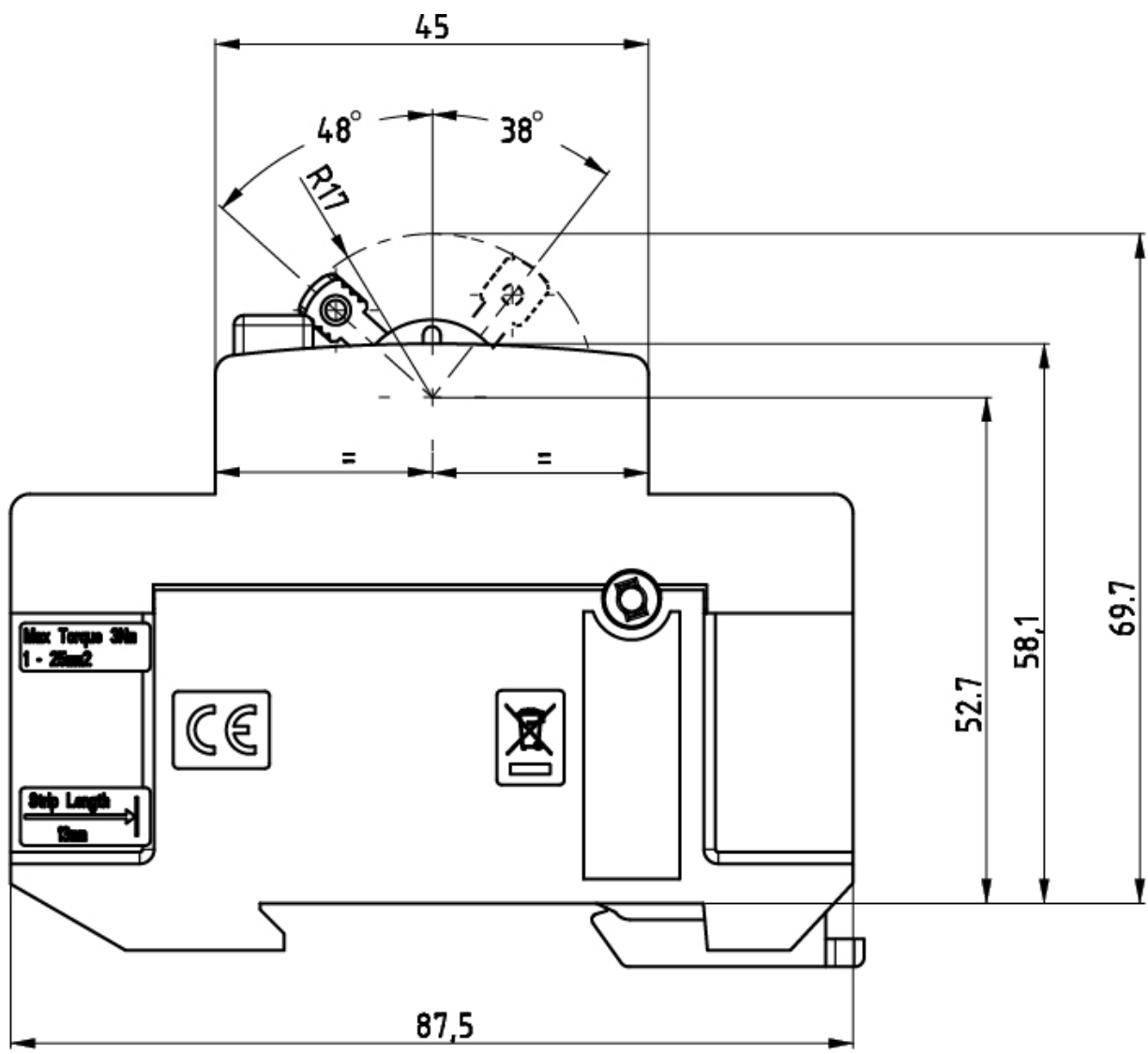

## Schema de conexiuni

