

ETITEC C T2 275/20 3+1



Specificatii

Cod ETI	002440403
Descriere	ETITEC C T2 275/20 3+1
Denumire clasă	Protecție supratensiuni
Funcție	SPD
Tip	T2
Imax(8/20) [kA]	40
Uc Tensiune de lucru continuă (V)	275
Semnalare la distanță	NU
Sistem rețea	TT/TNS
Grup Catalog	ETITEC C
In (8/20)	20
Numarul de module	3
Parte superioara - Nivel de protectie a tensiunii (kV)	<1,5
Curent de scurgere	DA
Tehnologie aplicata	MOV
Adancime incorporata (mm)	68

[Pagina de produse online](#)

Alta documentatie



[Catalog caracteristici tehnice](#)
[Model 3D](#)
[Manual de instructiuni](#)
[Declaratie CE](#)

Desen cotat

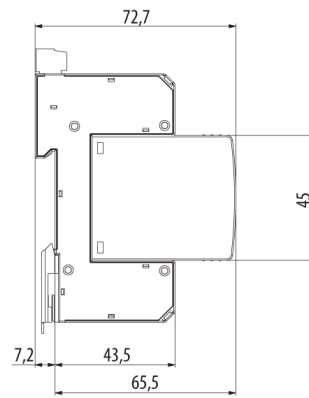
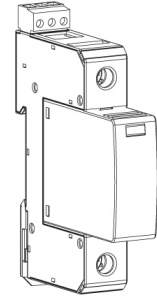
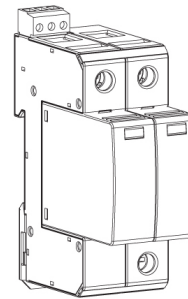
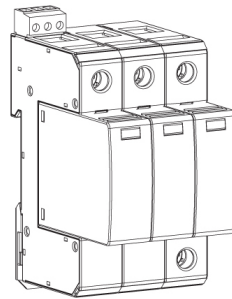
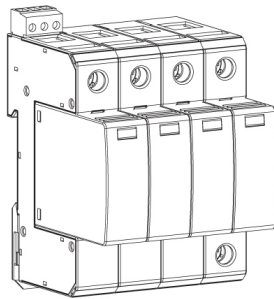
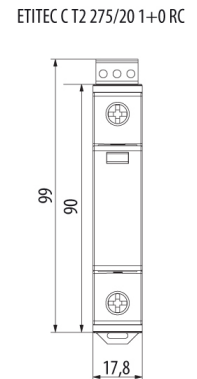
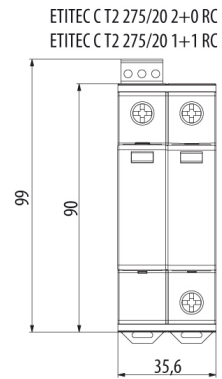
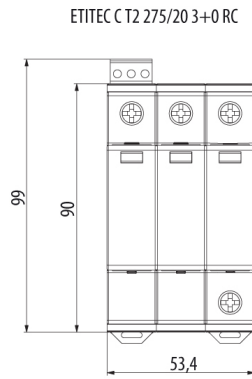
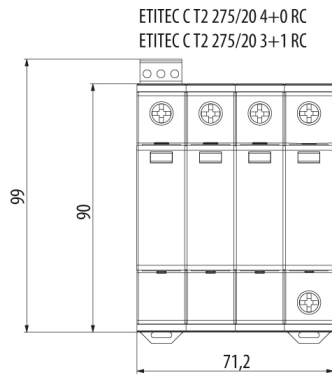

Simbol/Conexiune

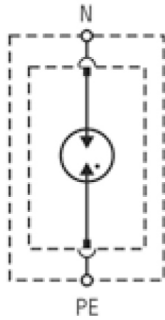

ETITEC T2 G

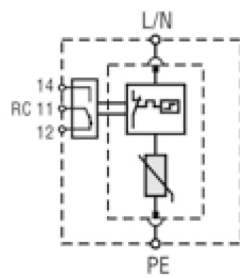

ETITEC T2 1+0 RC

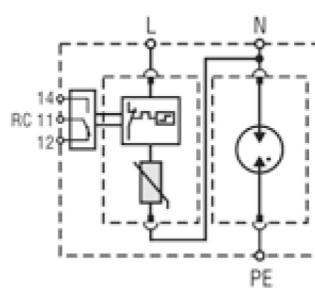

ETITEC T2 1+1 RC

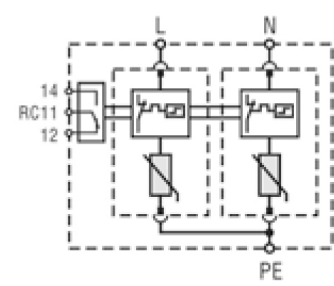

ETITEC T2 2+0 RC

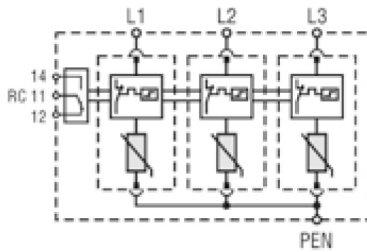

ETITEC T2 3+0 RC

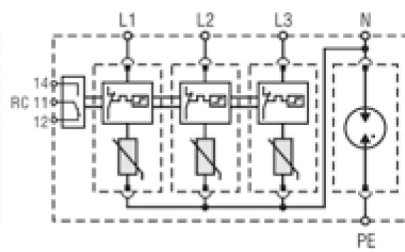

ETITEC T2 3+1 RC

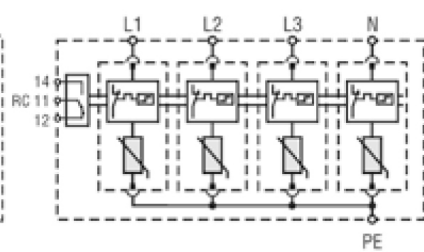

ETITEC T2 4+0 RC